

## God's Promise

God finally told Noah, his family, and the animals to leave the ark, multiply, and fill the earth. He also made a promise to never again destroy every living thing on the earth with a flood. God said this promise would last forever, and He placed the rainbow in the sky as a sign.

*"And you, be fruitful and multiply, increase greatly on the earth and multiply in it." Then God said to Noah and to his sons with him, "Behold, I establish my covenant with you and your offspring after you, and with every living creature that is with you, the birds, the livestock, and every beast of the earth with you, as many as came out of the ark; it is for every beast of the earth. I establish my covenant with you, that never again shall all flesh be cut off by the waters of the flood, and never again shall there be a flood to destroy the earth."*

*And God said, "This is the sign of the covenant that I make between me and you and every living creature that is with you, for all future generations: I have set my bow in the cloud, and it shall be a sign of the covenant between me and the earth. When I bring clouds over the earth and the bow is seen in the clouds, I will remember my covenant that is between me and you and every living creature of all flesh. And the waters shall never again become a flood to destroy all flesh. When the bow is in the clouds, I will see it and remember the everlasting covenant between God and every living creature of all flesh that is on the earth." God said to Noah, "This is the sign of the covenant that I have established between me and all flesh that is on the earth." Genesis 9:7-17*

Follow these instructions to draw a picture representing God's promise like the one shown below:

- Decide if you want to draw the right half of the picture or the left half of the picture and draw it in one of the first two grids. You can draw both if you'd like. Don't worry if you can't draw every detail. Just do your best and draw as much of the picture as you can.
- Now, using a blank grid, try drawing the whole picture.

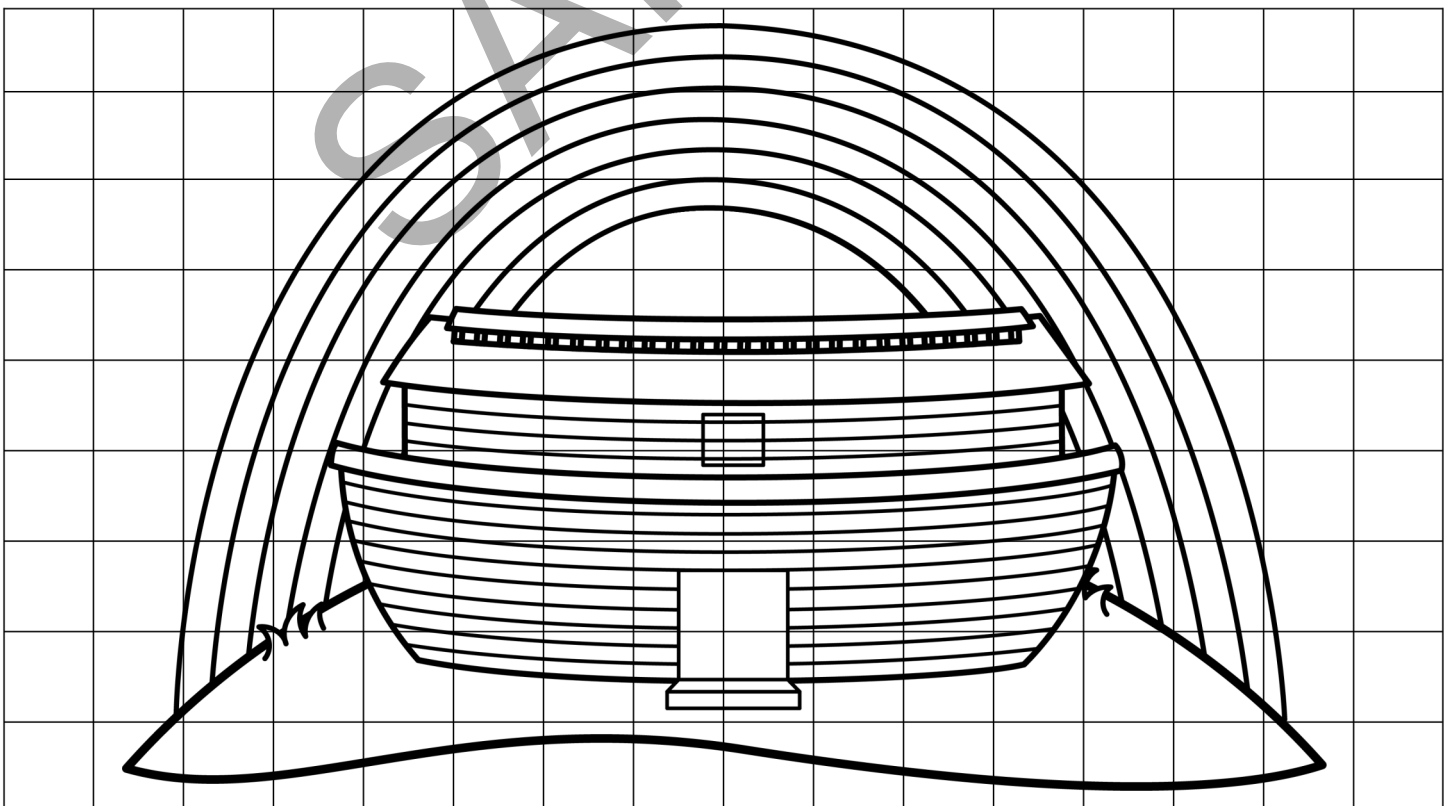

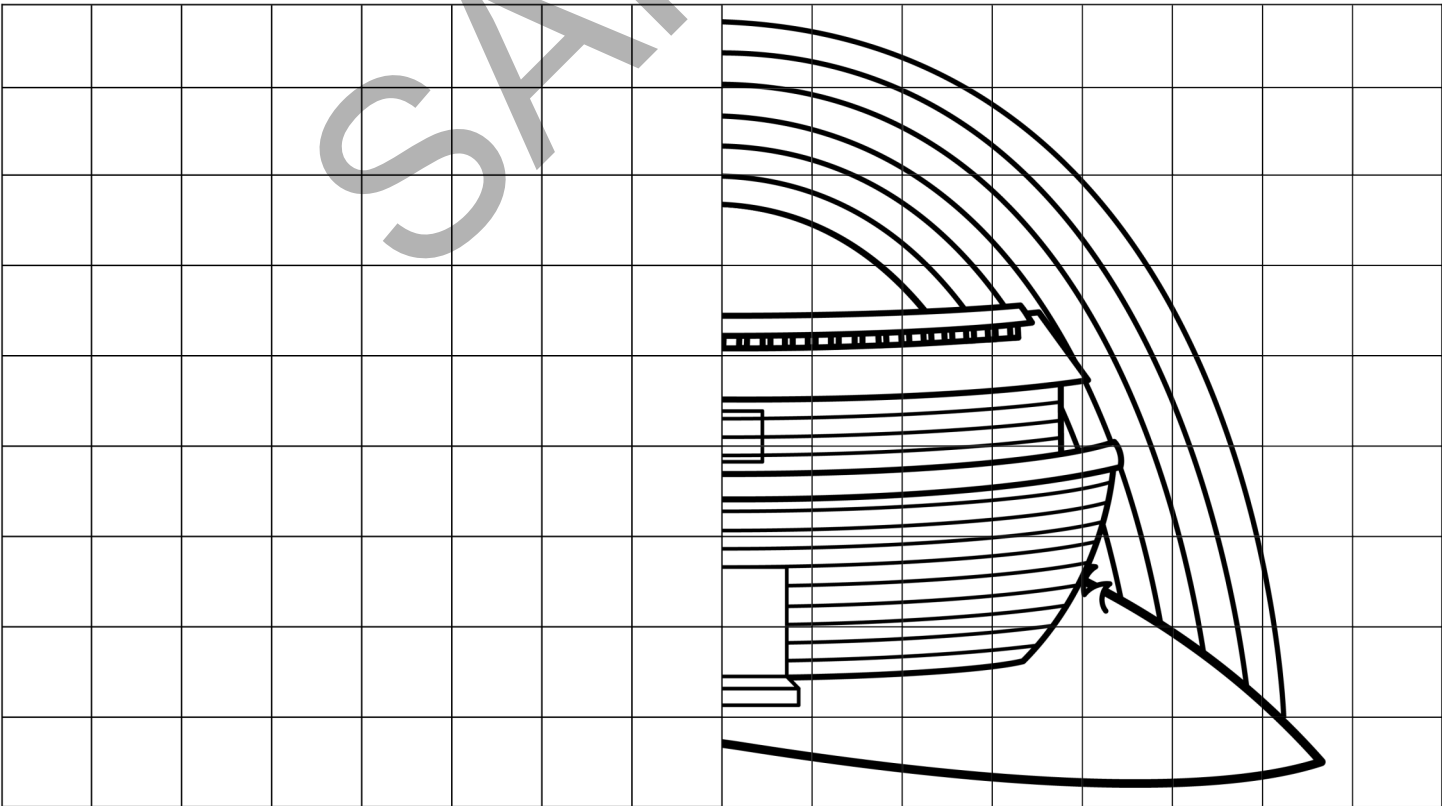
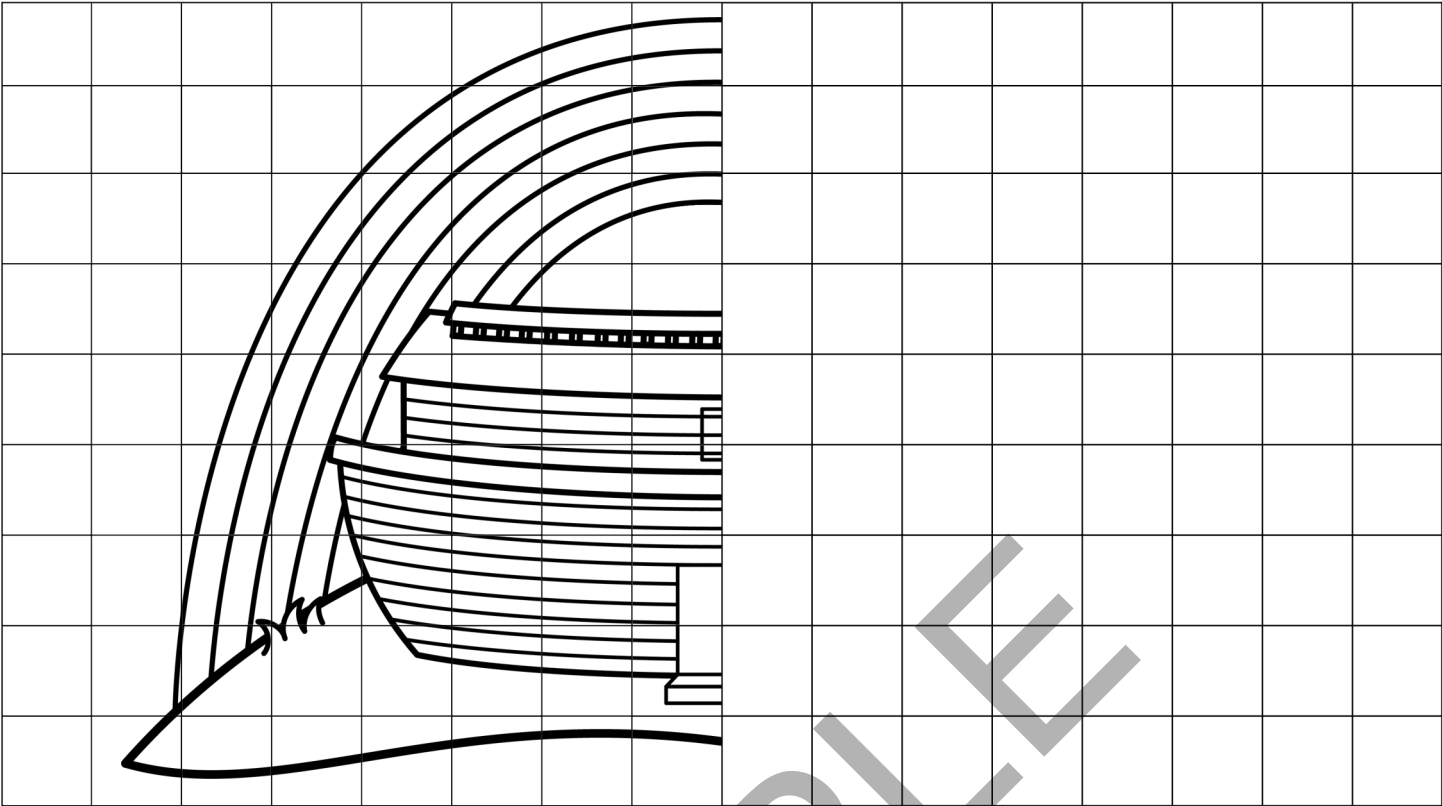

# Identify the Image

1. Which picture represents "Birds Enter the Ark"? Circle it.

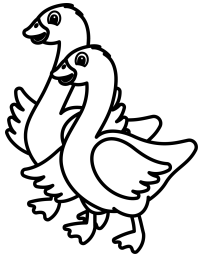

2. Which picture represents "God's Promise"? Circle it.

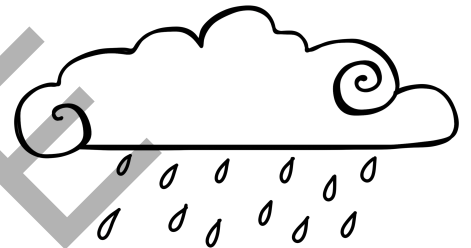
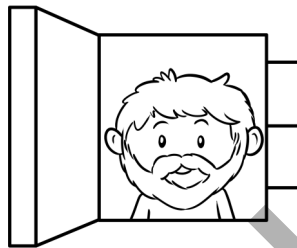
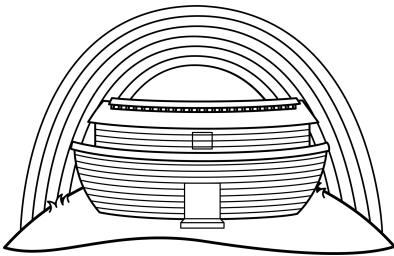

3. Which picture represents "So Much Evil"? Circle it.

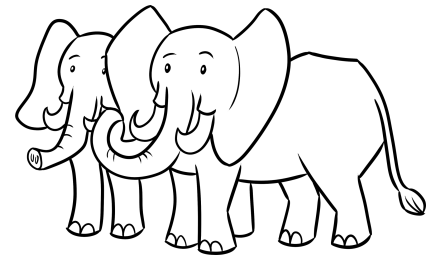

4. Which picture represents "The Ark Rests on Land"? Circle it.

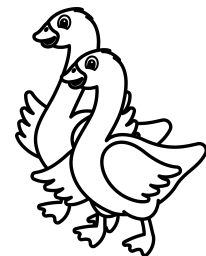
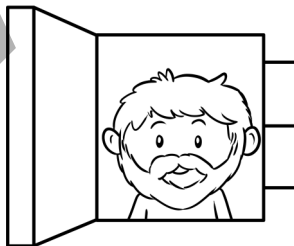

5. Which picture represents "The Rain Comes"? Circle it.

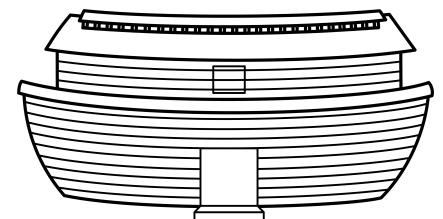
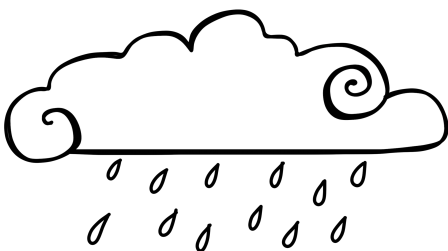

# Chronological Order

Look at the pictures below. They each represent a part of the story of Noah's ark. Put a number on the line next to each event to show the order they happened in.

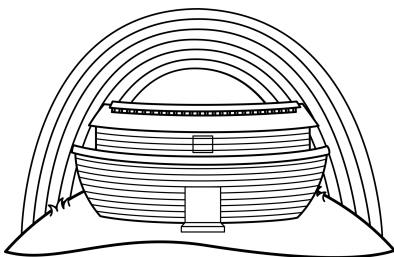
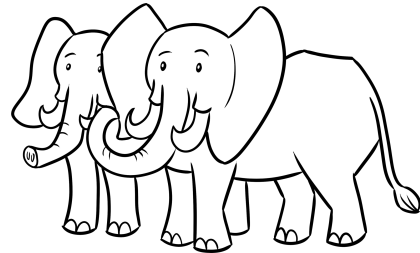
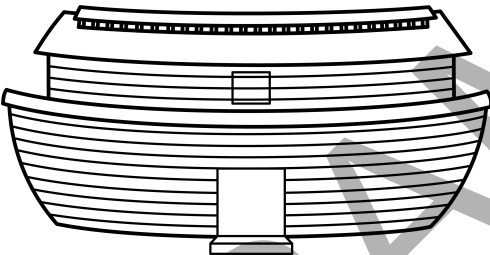
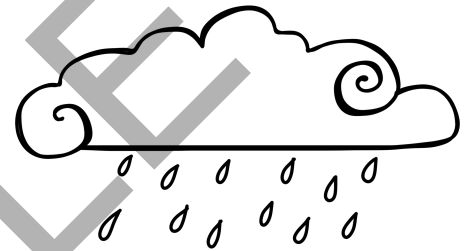
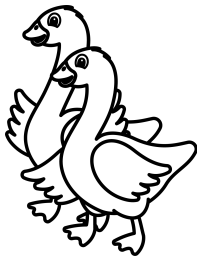
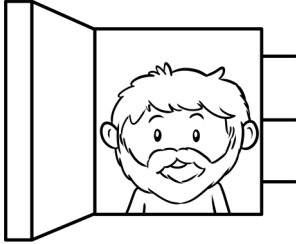

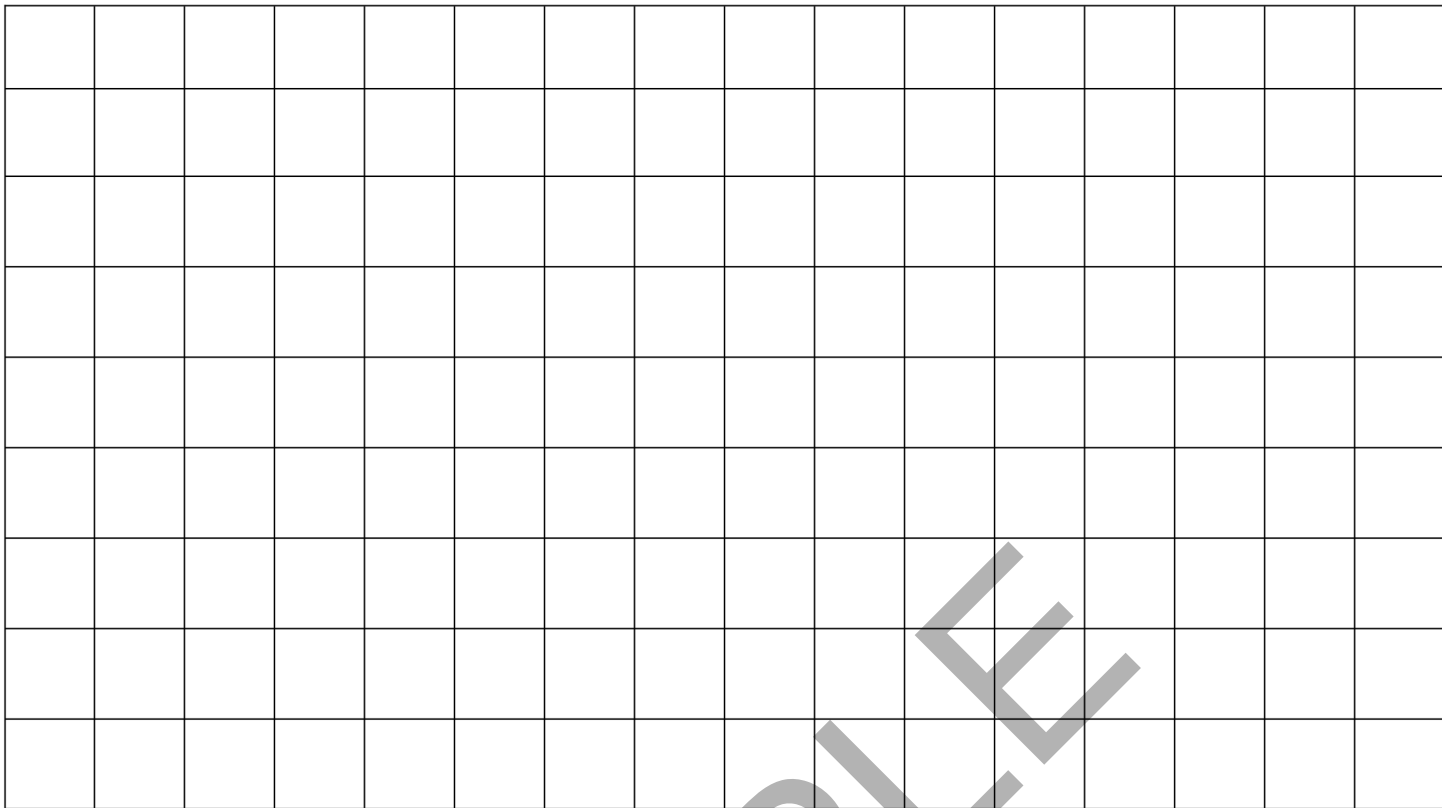

SAMPLE

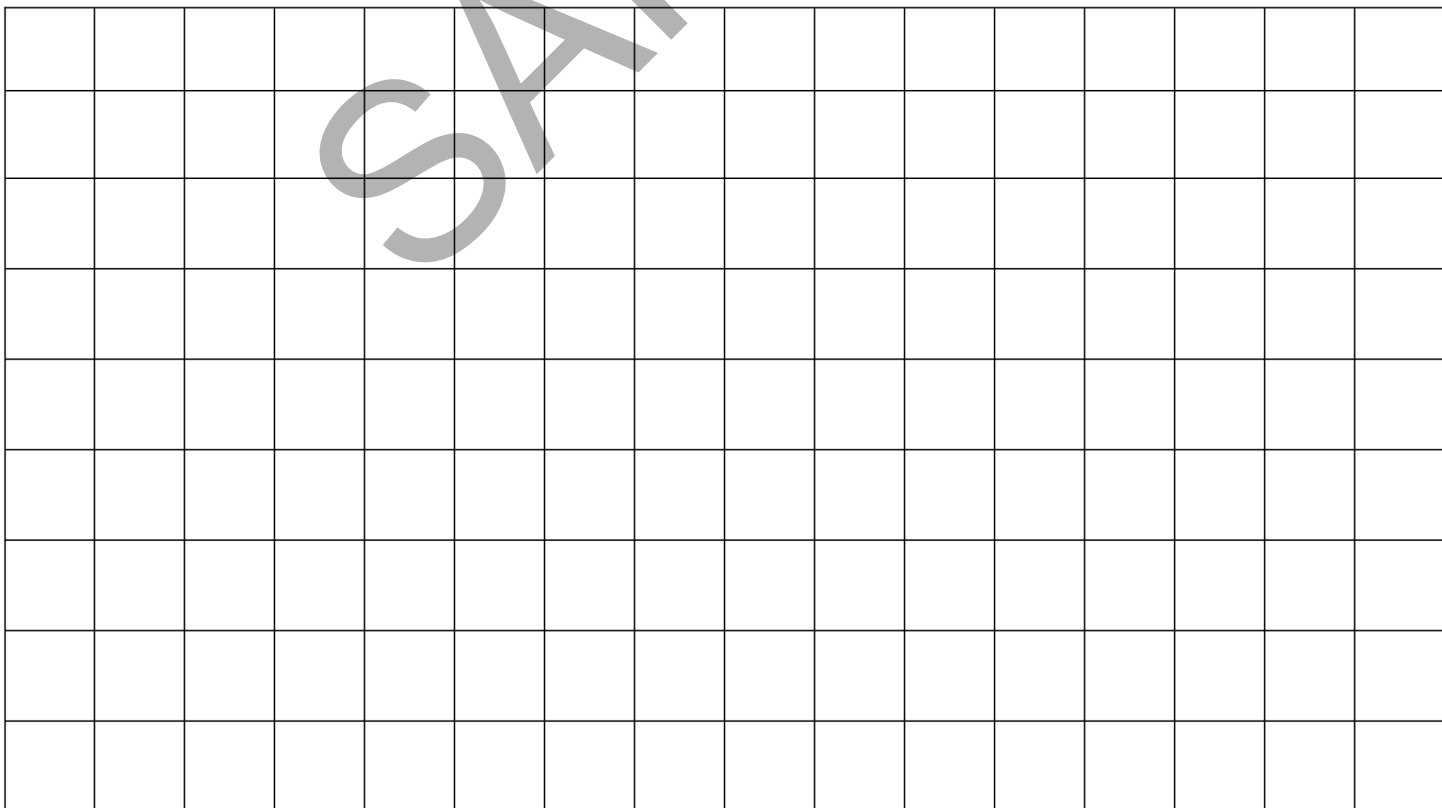

# Answer Key

## Identify the Image

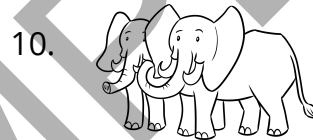
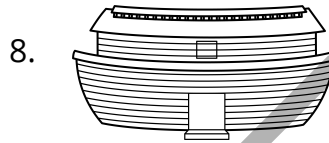
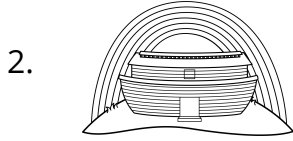
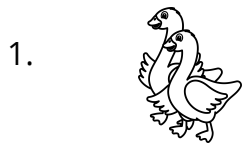

## Chronological Order

