

## God's Promise

God finally told Noah, his family, and the animals to leave the ark, multiply, and fill the earth. He also made a promise to never again destroy every living thing on the earth with a flood. God said this promise would last forever, and He placed the rainbow in the sky as a sign.

*"And you, be ye fruitful, and multiply; bring forth abundantly in the earth, and multiply therein." And God spake unto Noah, and to his sons with him, saying, "And I, behold, I establish my covenant with you, and with your seed after you; and with every living creature that is with you, of the fowl, of the cattle, and of every beast of the earth with you; from all that go out of the ark, to every beast of the earth. And I will establish my covenant with you, neither shall all flesh be cut off any more by the waters of a flood; neither shall there any more be a flood to destroy the earth."*

*And God said, "This is the token of the covenant which I make between me and you and every living creature that is with you, for perpetual generations: I do set my bow in the cloud, and it shall be for a token of a covenant between me and the earth. And it shall come to pass, when I bring a cloud over the earth, that the bow shall be seen in the cloud: And I will remember my covenant, which is between me and you and every living creature of all flesh; and the waters shall no more become a flood to destroy all flesh. And the bow shall be in the cloud; and I will look upon it, that I may remember the everlasting covenant between God and every living creature of all flesh that is upon the earth." And God said unto Noah, "This is the token of the covenant, which I have established between me and all flesh that is upon the earth." Genesis 9:7-17*

Follow these instructions to draw a picture representing God's promise like the one shown below:

- Decide if you want to draw the right half of the picture or the left half of the picture and draw it in one of the first two grids. You can draw both if you'd like. Don't worry if you can't draw every detail. Just do your best and draw as much of the picture as you can.
- Now, using a blank grid, try drawing the whole picture.

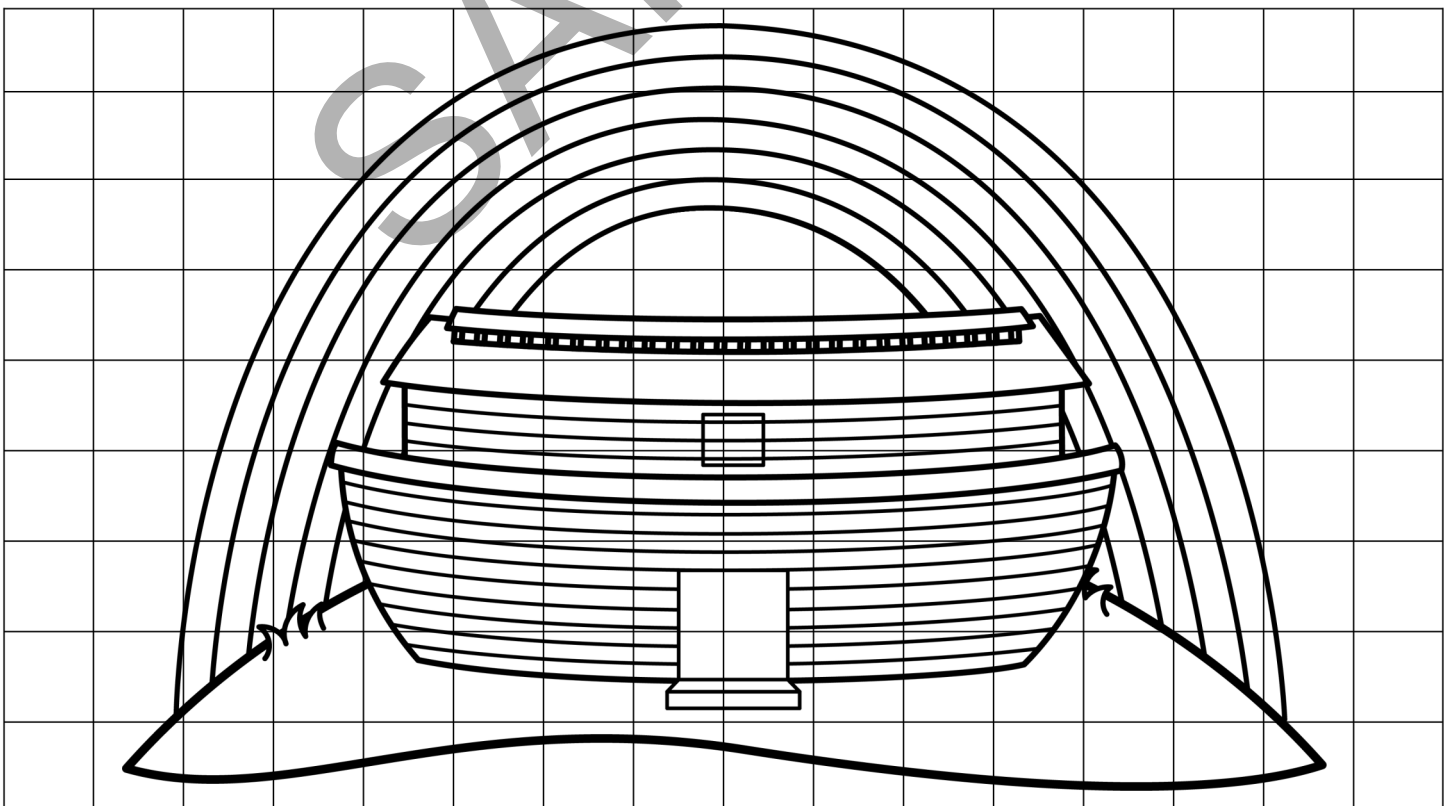

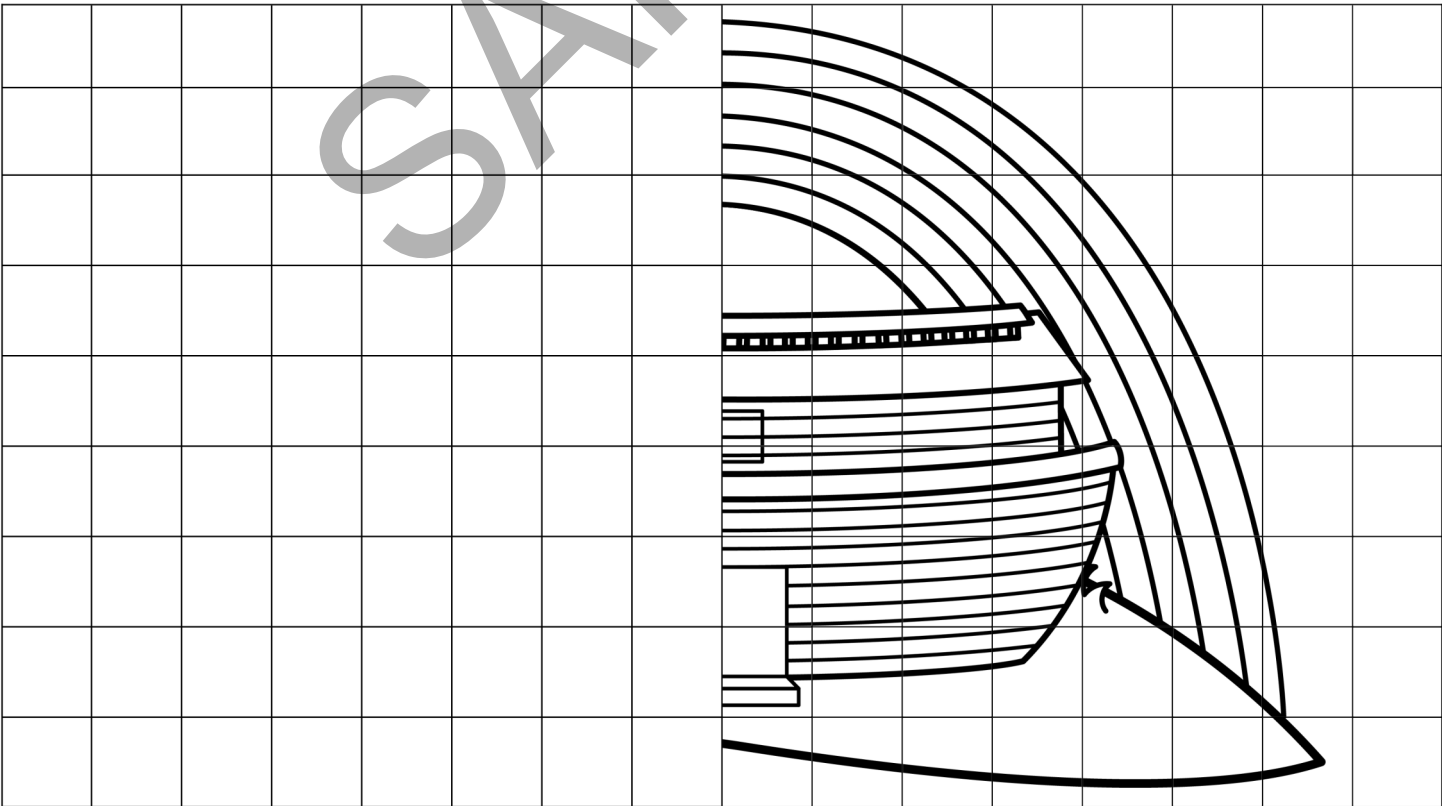
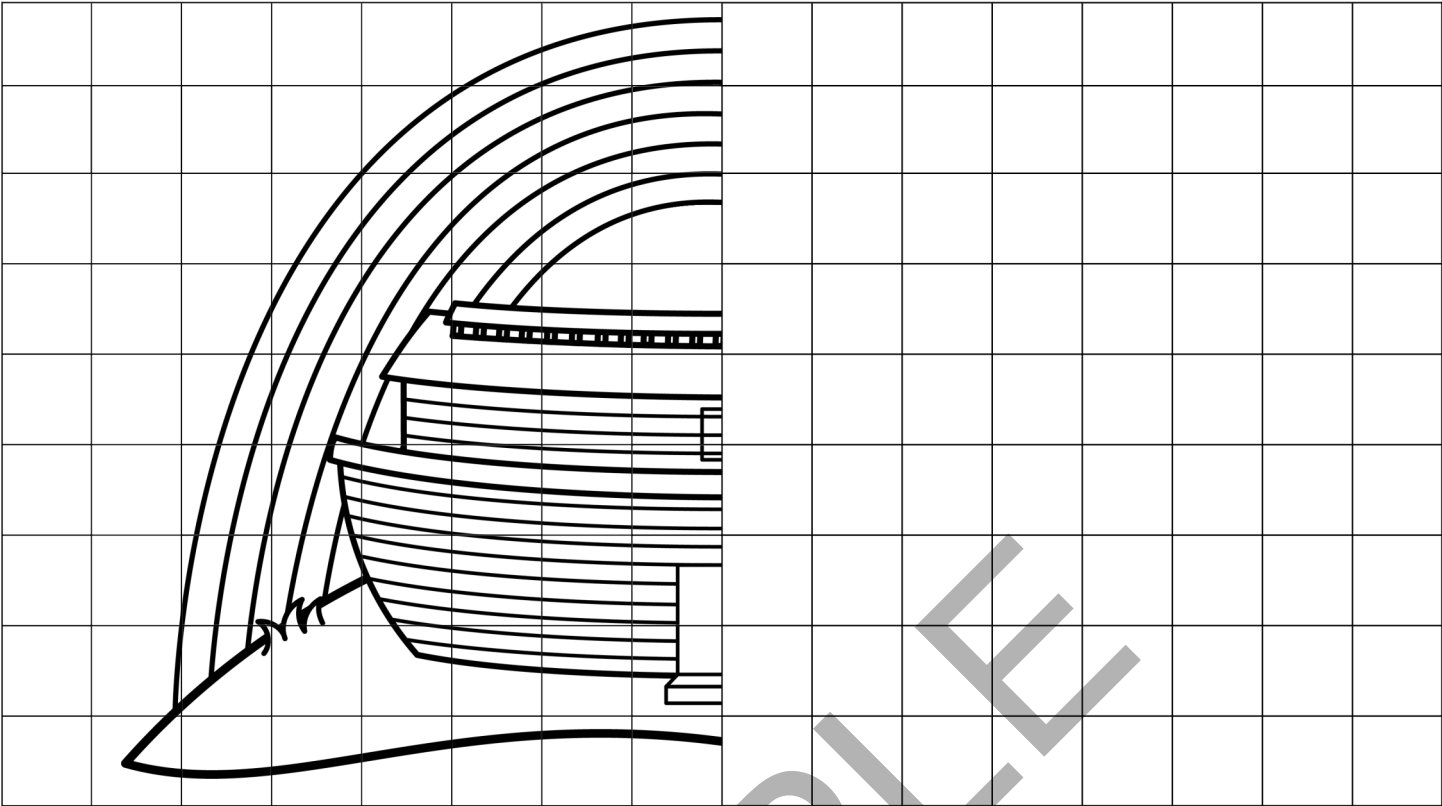

# Identify the Image

1. Which picture represents "Birds Enter the Ark"? Circle it.

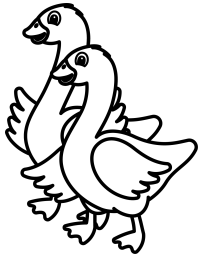

2. Which picture represents "God's Promise"? Circle it.

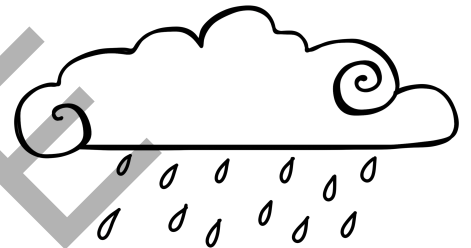
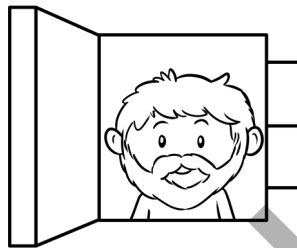
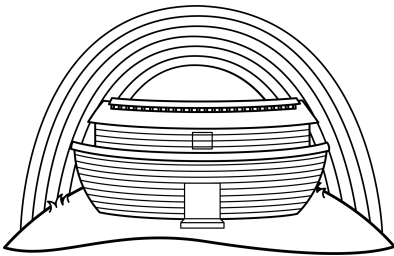

3. Which picture represents "So Much Evil"? Circle it.

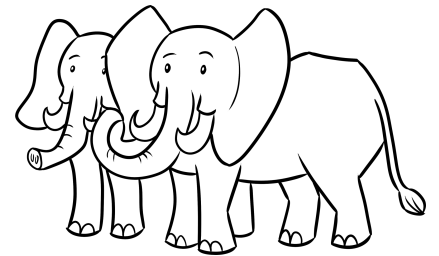

4. Which picture represents "The Ark Rests on Land"? Circle it.

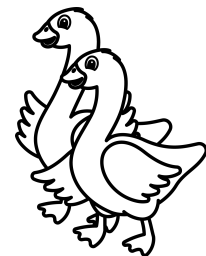
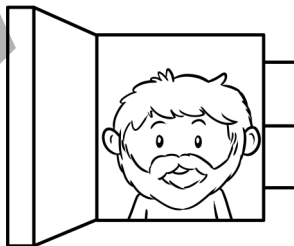

5. Which picture represents "The Rain Comes"? Circle it.

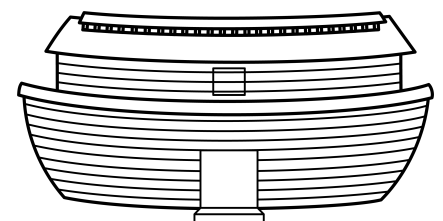
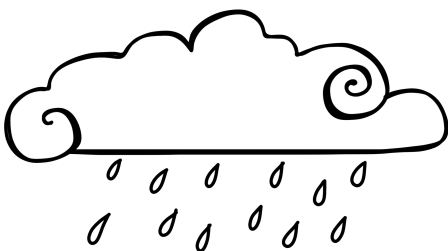

# Chronological Order

Look at the pictures below. They each represent a part of the story of Noah's ark. Put a number on the line next to each event to show the order they happened in.

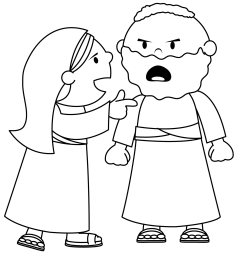
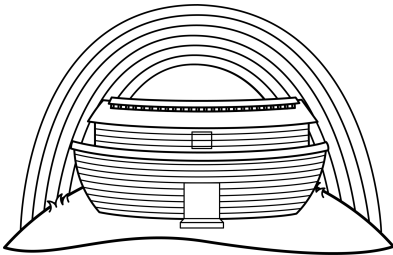
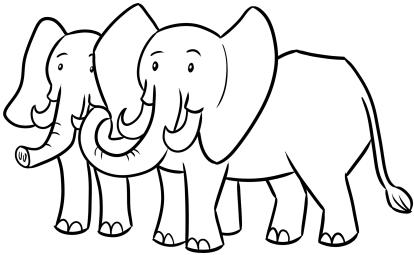
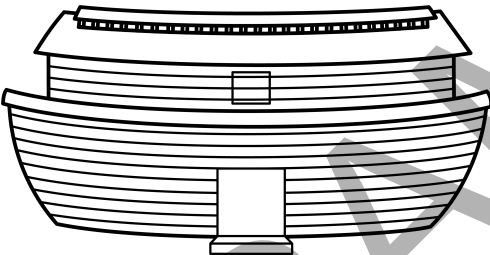
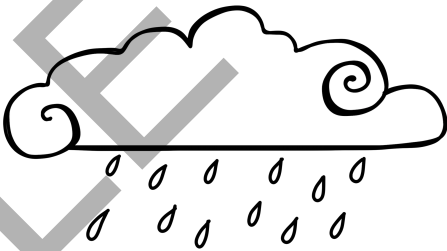
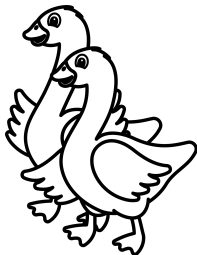
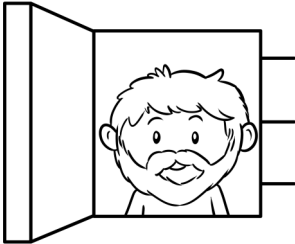

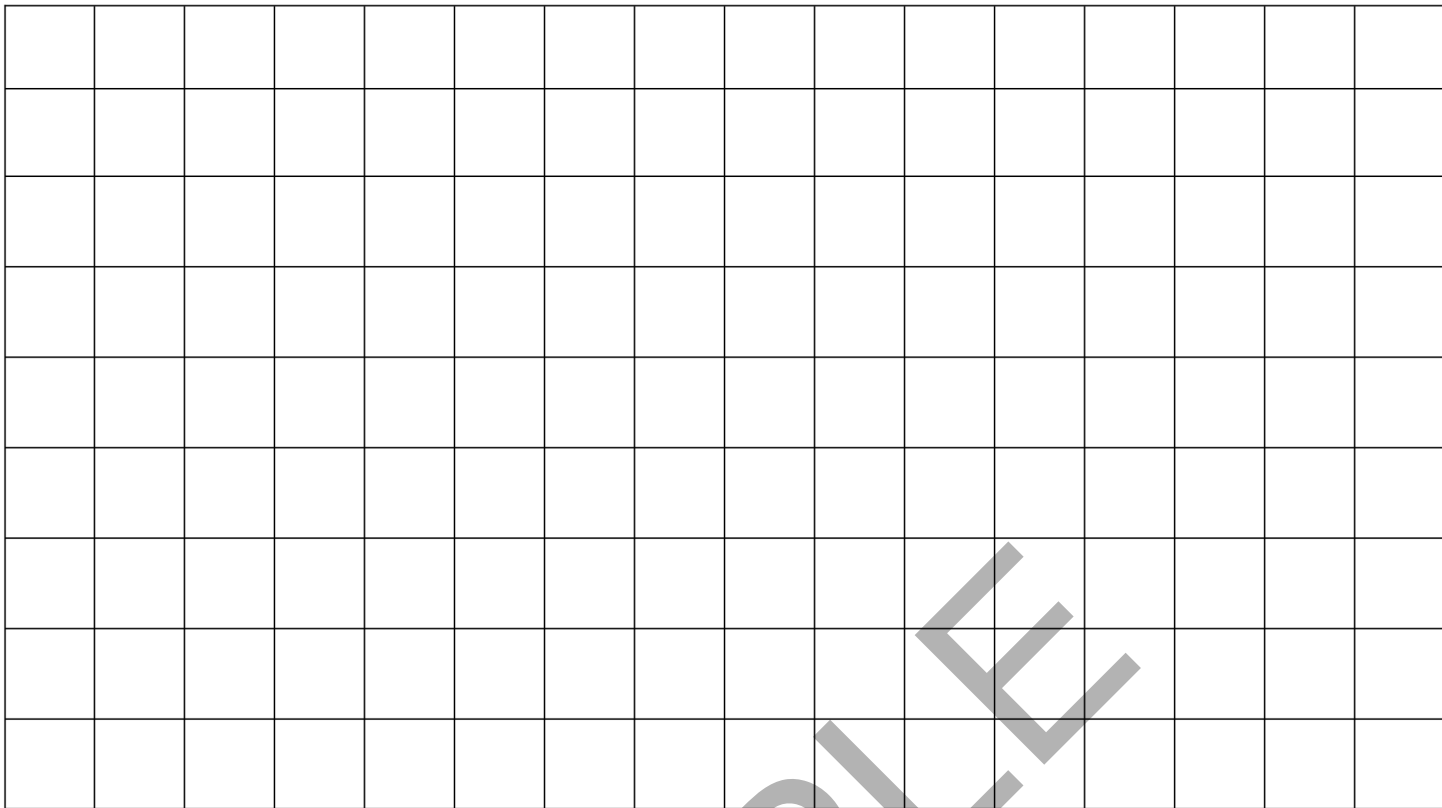

SAMPLE

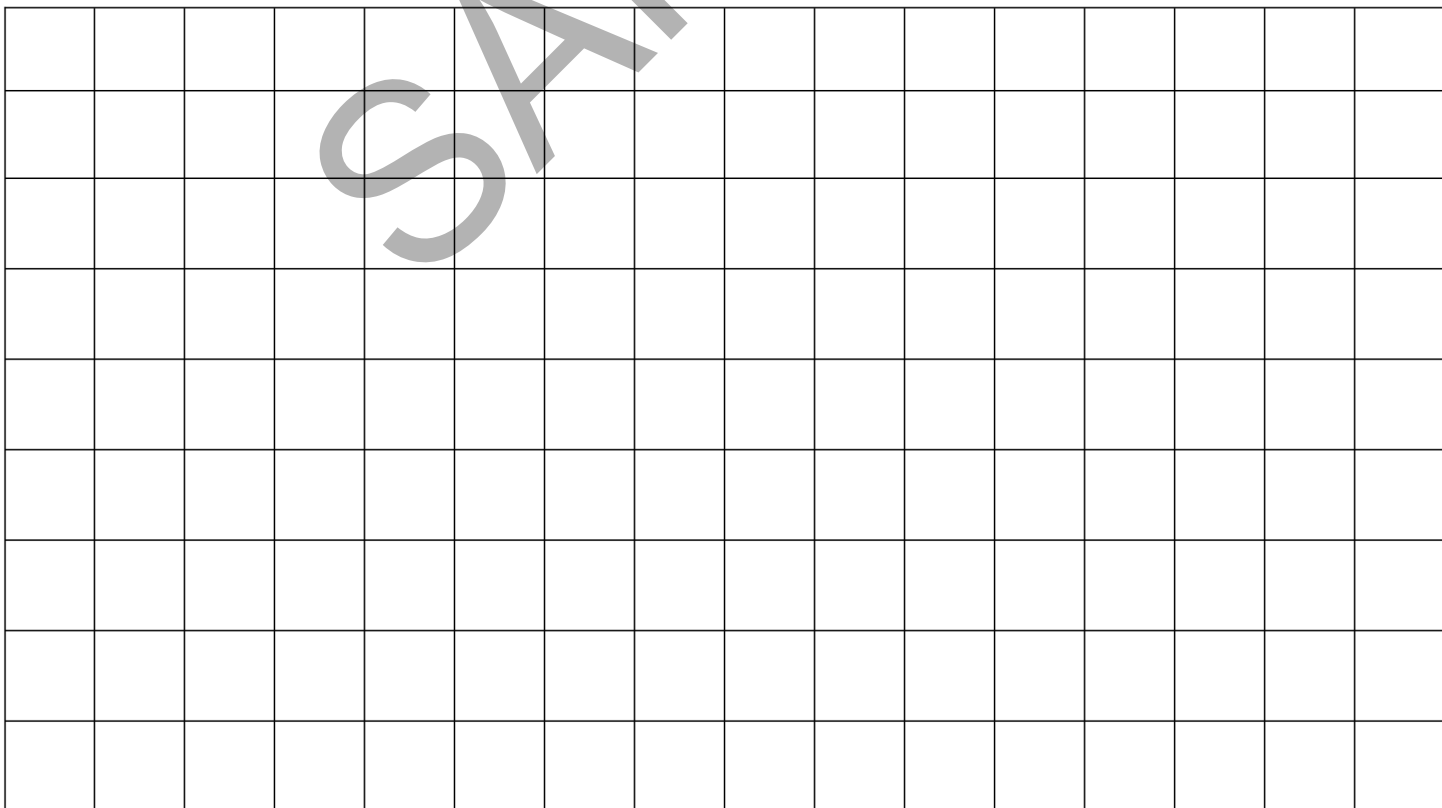

# Answer Key

## Identify the Image

1.



2.

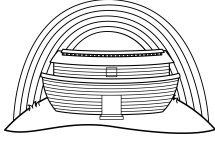

3.



4.

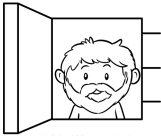

5.



6.



7.



8.

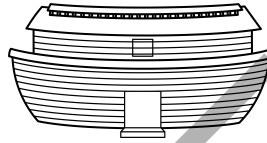

9.



10.

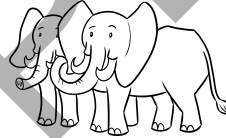

## Chronological Order

\_8\_

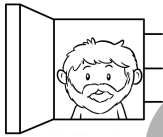

\_6\_



\_2\_

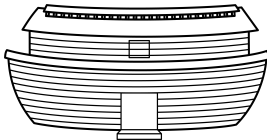

\_4\_



\_10\_



\_3\_



\_7\_

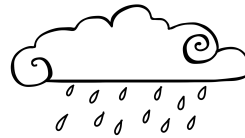

\_9\_



\_5\_

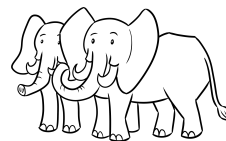

\_1\_

